

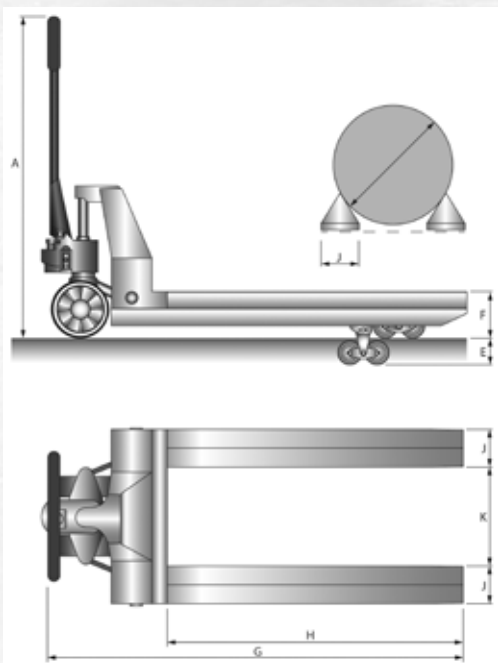

ROLLENHUBWAGEN PLUS+



Artikel	RPT20RPD700	
Antrieb		manuell
Deichselhöhe max., mm	A	1233
Gewicht, kg		149
Gabelbreite, mm	J	200
Gabelhöhe min., mm	F	175
Lenkrollen, mm		200x50 G
Gabelweite, mm	K	450
Gesamtlänge, mm	C	1600
Tragfähigkeit, kg		2000
für Rollendurchmesser, mm		600 - 800
Gabellänge, mm	H	1150
Gabelrolle tandem, mm		80x70 P
Hub, mm	E	115
Gabeltragbreite, mm		760
P=Polyurethan G=Gummi N=Nylon		